

# A-HD SERIES

INTERCHANGE > ISO 16028 - NFPA T3.20.15 - HTMA (size 3/8")















Stucchi®

FLAT FACE



## TECHNICAL FEATURES AND OPTIONS

 <b>Interchange</b> ISO 16028 NFPA T3.20.15 HTMA (size 3/8")	 <b>Sealing description</b> Nitrile NBR	 <b>Connection system</b> Push
 <b>Available sizes</b> from 3/8" to 1/2"	 <b>Material/treatment</b> Carbon steel /Cr3	 <b>Available threads</b> BSP - NPT - SAE
 <b>Operating pressure</b> Up to 350 bar	 <b>Locking mechanism</b> Locking ball + Safety Lock	 <b>Flow rate</b> Up to 90 l/min
 <b>Temperature (°C)</b> -20° / +100°	 <b>Valving style</b> Flat face	 <b>Connection under pressure</b> Connection: Female side only (see Benefits). Disconnection: Not allowed.

## BENEFITS

- Easy connection with female side under residual pressure (male side to drain) thanks to the special Stucchi design.
- Flat face is easy to clean, reducing the inclusion of contamination inside the hydraulic circuit.
- Minimal fluid spillage during disconnection, reducing fluid spillage to the environment.
- Minimal air inclusion during connection.
- Internal valve design creates minimal pressure drop and maintaining circuit efficiency in the system
- The modular design allows flexibility with a wide range of configurations.
- Good resistance to pressure impulses.
- Galvanized black body for easy identification
- Compact slim design.
- Safe and simple to use.

## HOW TO USE

- Before to connect, clean the mating surface of the couplings to avoid dirt inclusion in the circuit.
- To connect push the male half towards the female half or vice versa.
- After connection turn the external sleeve to engage safety lock function, to prevent accidental disconnection.
- To disconnect turn the external sleeve until the sleeve lock notch match the safety lock ball and push back the sleeve.

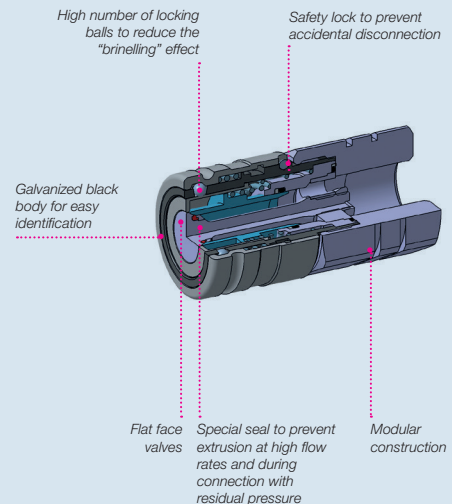
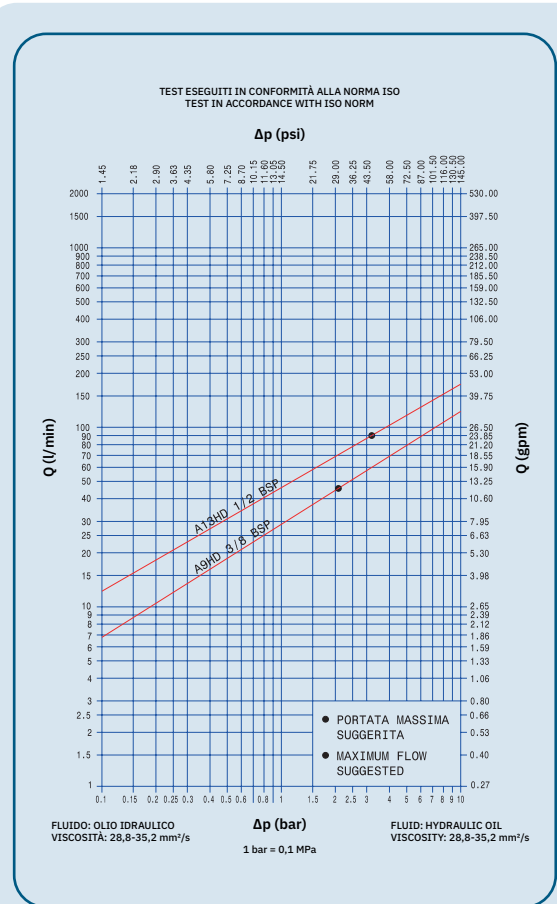

## MAIN APPLICATIONS

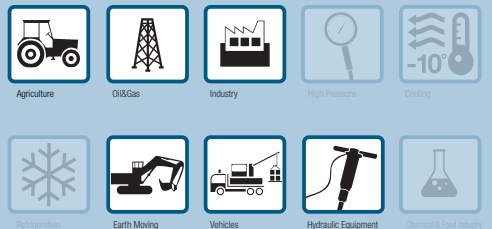

## PERFORMANCES

Size		Series/Size	Max. flow suggested		Connect force		Disconnect force		Spillage*
Inch	mm (ISO)		l/min	gpm	N	lbf	N	lbf	ml
3/8	10	F -A9HD	46	12,19	190	42,75	30	6,75	0,01
1/2	12,5	F- A13HD	90	23,85	170	38,25	55	12,37	0,02

Size	Series/Size	Max. operating pressure				Burst pressure			
		Coupled		Female		Coupled		Female	
Inch		MPa	psi	MPa	psi	MPa	psi	MPa	psi
3/8	F- A9HD	35	5075	35	5075	100	14500	100	14500
1/2	F- A13HD	33	4785	33	4785	100	14500	100	14500

\* Spillage is an indicative value of the fluid loss during disconnection (according to ISO norm test method).

### Theoretical calculation of connect force with residual pressure:

$$F_p (N) \text{ size } 3/8" = F_i + (P_f \times 44)$$

$$F_p (N) \text{ size } 1/2" = F_i + (P_f \times 66)$$

$F_p$  = Connection force with residual pressure (N)

$F_i$  = Connection force without residual pressure (N)

$P_f$  = Residual pressure in the female coupling (MPa)

### EXAMPLE

To connect the female coupling A9HD with 5 Mpa of residual pressure, the following force is necessary:

$$F_p = F_i + (P_f \times 44) = 190 + (5 \times 44) = 410 \text{ N}$$

This is the maximum force required to open the female valve in order to release pressure.

It is not necessary to apply this force during the entire connection but just for a short stroke (about 1 mm).

### Different possible configurations:

Different threads available upon request.

### Temperature range:

Standard seals in NBR, PUR, POM: from -20 °C to +100 °C (from -4 °F to +212 °F).

Please read carefully Instructions and warnings for proper selection of the products.

### Tests performed:

Tested with male couplings "A" series

The couplings have been tested at max. operating pressure for 1.000.000 impulses in connected position according to ISO norm test method.

## ! WARNING

A defect, a wrong choice or an improper use of products, can cause injury to persons, animals and objects.

Connect under pressure products are suitable to be connected under residual (static) pressure.

Never connect or disconnect with dynamic pressure (e.g. pump on).

Connection with residual pressure (pressure trapped in the circuit) allowed with male to drain (please check the hydraulic circuit).

Do not use the female coupling disconnected with high impulse pressure.

Do not couple-uncouple with flow in the circuit.

Do not couple-uncouple when the temperature inside of the circuit is higher than 80 °C (176 °F).

Check the maximum allowable working pressure of the port in use.

Make sure that the medium used is compatible with seal and material as indicated for each series.

In case of doubt please contact Stucchi Technical Support.

The interchangeability is mentioned under the assumption that the manufacturer of the considered products has not changed any dimension.

**It is mandatory to carefully read and closely follow the instructions before selecting or using any Stucchi products.**

**Always refer to the version uploaded in the Instructions and warning section of [stucchigroup.com](http://stucchigroup.com) website for the latest release.**

**For specific, product-related, instructions, please contact Stucchi technical service.**

## OVERALL DIMENSIONS

FLAT FACE

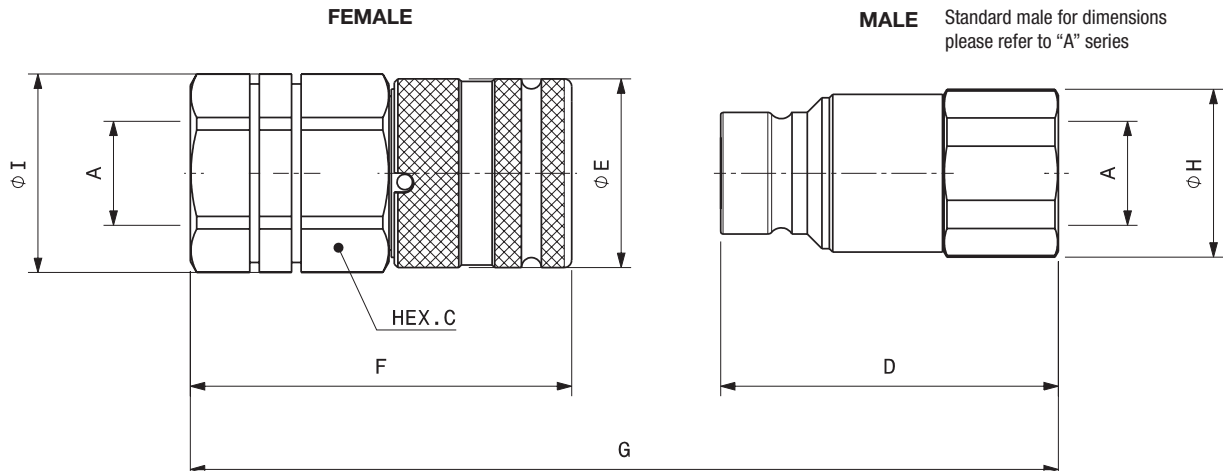

### Port description: FEMALE THREAD BSPP (ISO 1179-1)

BODY SIZE	Descriptive Code	Item Code	ISO DN	PORT (A)	Overall Length		Length		Hex		Diameter		Diameter		Weight						
					mm	inch	mm	inch	mm	inch	mm	inch	mm	inch	Kg	Lbs					
3/8"	F A9HD 3/8 BSP	Female 808300004	10,0	3/8"	G	(F+D)-16	(F+D)-0,630	F	64,8	2,55	C	30,0	1,18	I	32,0	1,26	E	32,0	1,26	0,28	0,62
3/8"	F A9HD 1/2 BSP	Female 808300006	10,0	1/2"	G	(F+D)-16	(F+D)-0,630	F	69,8	2,75	C	30,0	1,18	I	32,0	1,26	E	32,0	1,26	0,29	0,64
1/2"	F A13HD 1/2 BSP	Female 808300008	12,5	1/2"	G	(F+D)-17,3	(F+D)-0,681	F	76,8	3,02	C	36,0	1,42	I	40,0	1,57	E	38,0	1,50	0,47	1,03
1/2"	F A13HD 3/4 BSP	Female 808300010	12,5	3/4"	G	(F+D)-17,3	(F+D)-0,681	F	83,8	3,30	C	36,0	1,42	I	40,0	1,57	E	38,0	1,50	0,48	1,06

### Port description: FEMALE THREAD NPT (ANSI B.1.20.1)

BODY SIZE	Descriptive Code	Item Code	ISO DN	PORT (A)	Overall Length		Length		Hex		Diameter		Diameter		Weight						
					mm	inch	mm	inch	mm	inch	mm	inch	mm	inch	Kg	Lbs					
1/2"	F A13HD 1/2 NPT	Female 808301008	12,5	1/2"	G	(F+D)-16	(F+D)-0,630	F	76,8	3,02	C	36,0	1,42	I	40,0	1,57	E	38,0	1,50	0,47	1,04
1/2"	F A13HD 3/4 NPT	Female 808301010	12,5	3/4"	G	(F+D)-16	(F+D)-0,630	F	83,8	3,30	C	36,0	1,42	I	40,0	1,57	E	38,0	1,50	0,49	1,07

### Port description: FEMALE THREAD SAE (ISO 11926-1 & SAE J1926-1)

BODY SIZE	Descriptive Code	Item Code	ISO DN	PORT (A)	Overall Length		Length		Hex		Diameter		Diameter		Weight						
					mm	inch	mm	inch	mm	inch	mm	inch	mm	inch	Kg	Lbs					
3/8"	F A9HD 1/2 SAE	Female 808304008*	10,0	3/4-16 UNF	G	(F+D)-16	(F+D)-0,630	F	69,8	2,75	C	30,0	1,18	I	32,0	1,26	E	32,0	1,26	0,30	0,66
3/8"	F A9HD 5/8 SAE	Female 808304010*	10,0	7/8-14UNF	G	(F+D)-17,3	(F+D)-0,681	F	71,8	2,83	C	30,0	1,18	I	32,0	1,26	E	32,0	1,26	0,29	0,64
1/2"	F A13HD 1/2 SAE	Female 808304016	12,5	3/4-16UNF	G	(F+D)-17,3	(F+D)-0,681	F	76,8	3,02	C	36,0	1,42	I	40,0	1,57	E	38,0	1,50	0,48	1,05
1/2"	F A13HD 5/8 SAE	Female 808304012	12,5	7/8-14UNF	G	(F+D)-17,6	(F+D)-0,693	F	78,8	3,10	C	36,0	1,42	I	40,0	1,57	E	38,0	1,50	0,47	1,04
1/2"	F A13HD 3/4 SAE	Female 808304014	12,5	1-1/16-12UNF	G	(F+D)-22	(F+D)-0,866	F	83,8	3,30	C	36,0	1,42	I	40,0	1,57	E	38,0	1,50	0,47	1,03

\* Available upon request.

Also possible with following male threads:

- SAE
- JIC
- JIC Bulkhead

Please check availability by contacting your Stucchi contact

To calculate G see measure D in the leaflet A series

**Panel mounting**

A-HD Series is available upon request also as panel mounting version.

BC: Snap Ring Solution  
Grooves on the female sleeve.

BR: Snap Ring Solution  
Grooves on the female adaptor.

BT: Lock Ring Solution  
Thread on the female body.

For specific codes, dimensions or any other information, please contact Stucchi Technical Support.

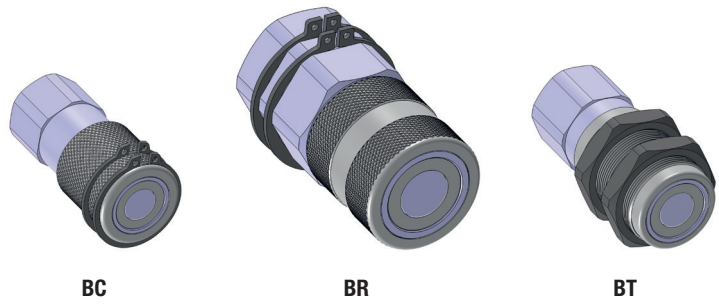
**SS version**

For specific cases, A-HD Series is available upon request without the safety lock ball.

For additional information, please contact Stucchi Technical Support.

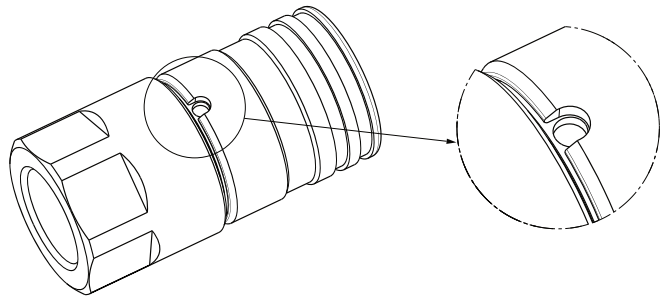
**PROTECTIVE CAPS FOR A-HD SERIES**

Protective caps are always recommended to protect the couplings from damage, dirt inclusion, and will increase the product life. This is particularly important in mobile applications where exposure to weather and aggregate materials are common.

The protective caps for A-HD couplings are manufactured in two versions:

- Plastic with connection lanyard (standard color red, other colors available upon request).
- Plastic flip caps version (standard color red, other colors available upon request).

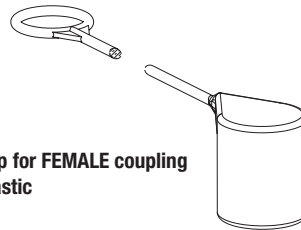

Cap for FEMALE coupling  
Plastic

Protective Cap		
Body Size/Description	Part Number	Material/Color
3/8" F A9HD	815100002	Plastic/Red
1/2" F A13HD	815100004	Plastic/Red

Flip cap for FEMALE coupling  
Plastic

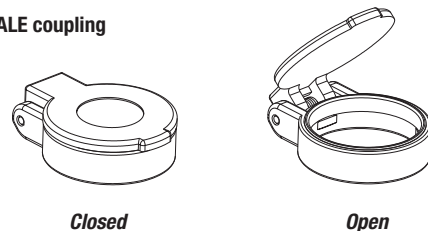

Closed

Open

Protective Cap		
Body Size/Description	Part Number	Material/Color
3/8" A9HD	815200002	Plastic/Red
1/2" A13HD	815200004	Plastic/Red